

KYOCERA Net Direct Print User Guide

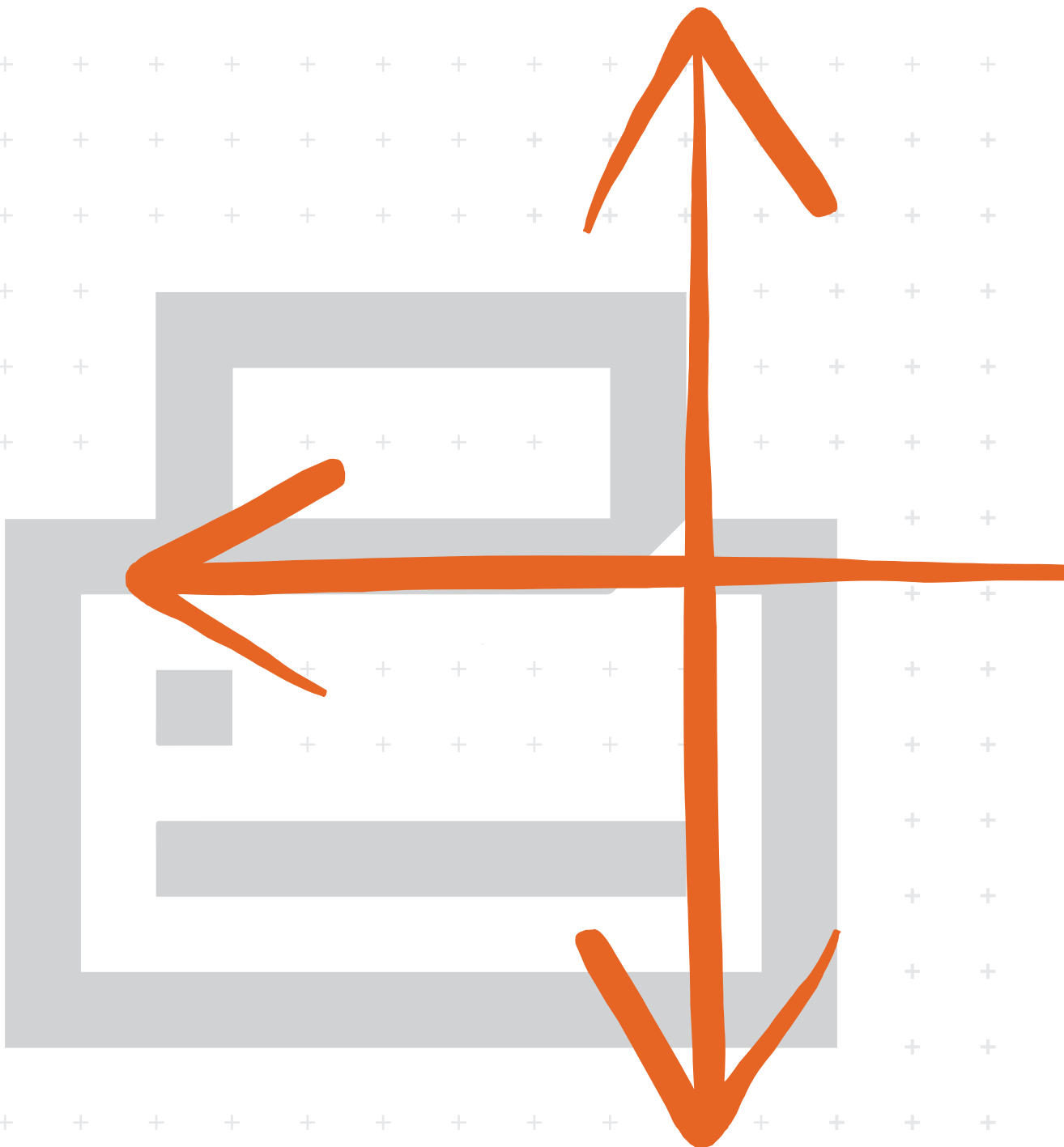

Legal and General Information

Notice

Unauthorized reproduction of all or part of this guide is prohibited. The information in this guide is subject to change without notice.

We cannot be held liable for any problems arising from the use of this product, regardless of the information herein.

Regarding Trademarks

Microsoft and Windows are registered trademarks of Microsoft Corporation.

Apple, AppleTalk, Mac, Macintosh, Mac OS and TrueType are registered trademarks of Apple Inc.

Adobe, Acrobat and Postscript are registered trademarks of Adobe Systems Incorporated.

Novell and NetWare are registered trademarks of Novell, Inc.

HP and PCL are registered trademarks of Hewlett-Packard Company.

Intel, Pentium and Celeron are registered trademarks of Intel Corporation.

Other brand and product names contained in this document are registered trademarks or trademarks of their respective companies.

General Information

When using this utility, the items that can be configured will differ depending on the model of your printing system or multifunctional printer (hereinafter referred to as "printing system").

Examples in this document are described in terms of the Microsoft Windows 10 operating system environment.

Table of Contents

1. Features	1
1.1. What is KYOCERA Net Direct Print?	1
1.2. System Requirements.....	1
1.3. Support Language	1
2. Installation and Startup	2
2.1. Installation.....	2
2.2. Startup	2
3. Printing PDF	3
4. Names and Functions	5
5. Printing System Settings	6
6. Detailed Settings	10



1. Features

1.1. What is KYOCERA Net Direct Print?

KYOCERA Net Direct Print is a utility that allows you to print PDF files downloaded from Internet such as catalog and documents without starting Adobe Acrobat/Reader.

1.2. System Requirements

The KYOCERA Net Direct Print operates in the following environment. Verify your environment before installation.

Item	Description
OS (Depending on the model)	Microsoft Windows Server 2008/2012/2016/2019† Microsoft Windows 7† Microsoft Windows 8.1† Microsoft Windows 10†
Hardware	A processor equivalent to a Pentium 200 MHz or greater At least 32 MB of free memory At least 4 MB of free hard disk space SVGA (800 × 600, 256 color) or greater

† Administrator rights are required for installation.

1.3. Support Language

KYOCERA Net Direct Print supports the following languages: Arabic, Brazilian Portuguese, Czech, Danish, Dutch, English, Finnish, Farsi, French, German, Hebrew, Hungarian, Italian, Japanese, Lithuanian, Korean, Norwegian, Polish, Portuguese, Russian, Simplified Chinese, Spanish, Swedish, Traditional Chinese and Turkish.

2. Installation and Startup

2.1. Installation

Install Network Tool for Direct Printing in your computer.

Note

Before installing this utility, make sure that any of the printer drivers are installed. The **Printer Driver** is provided on the **Product Library** disc supplied with the printing system.

Insert the **Product Library** disc that came with the printing system into the optical drive of the computer.

The installation program starts up automatically. Follow the instructions for installation.

2.2. Startup

When the installation is completed, you can start the **KYOCERA Net Direct Print** by proceeding from the start menu > **Kyocera** > **KYOCERA Net Direct Print**.

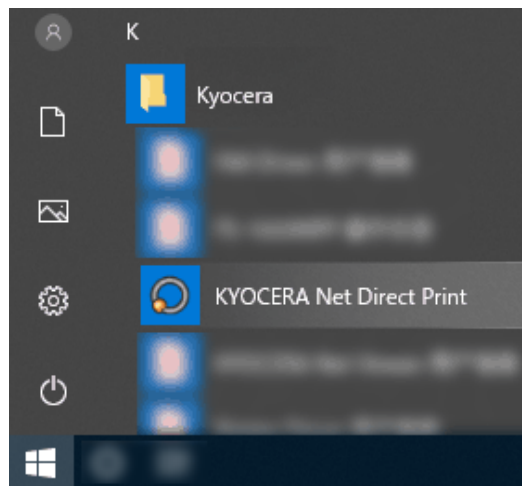

3. Printing PDF

Perform the following procedures below to print PDF file using **KYOCERA Net Direct Print**.

1 Start **KYOCERA Net Direct Print**.

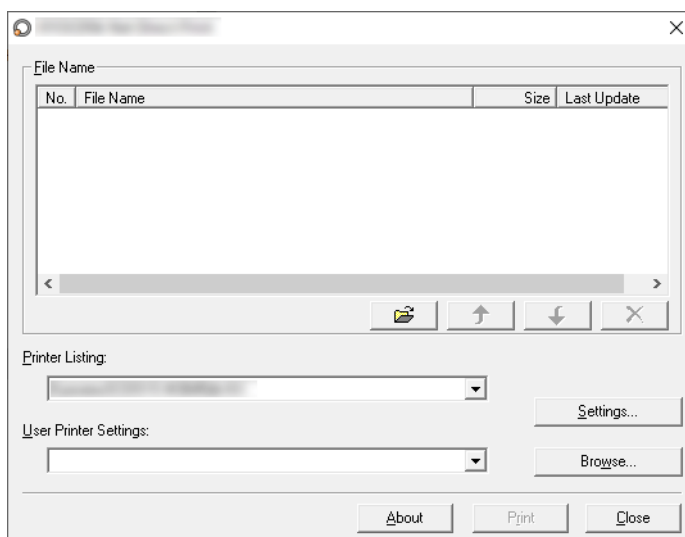

2 Add the desired PDF files to the **File Name** list by the following methods.

- Click the **Add** button to select files from the **Open File** dialog box.
- Select the file in Windows explorer and then drag and drop it to the icon for this application (including shortcut).
- Select the file in Windows explorer and then select **KYOCERA Net Direct Print** in the context menu.
- Select the file and then drag and drop it to this window.

3 Select the printing system to print PDF files from the **Printer Listing** pull-down menu.

4 Click the **Settings** button and make settings for printing. For details, refer to *Printing System Settings* on page 6.

Note

When you want to load the previously saved setting, select the setting file from the **User Printer Settings** pull-down menu or click the **Browse** button.

5 Click the **Detailed Settings** button and make the detailed settings such as page range for printing and media type. For details, refer to *Detailed Settings* on page 10.

6 Click the **Print** button. The **Confirmation** dialog box appears.

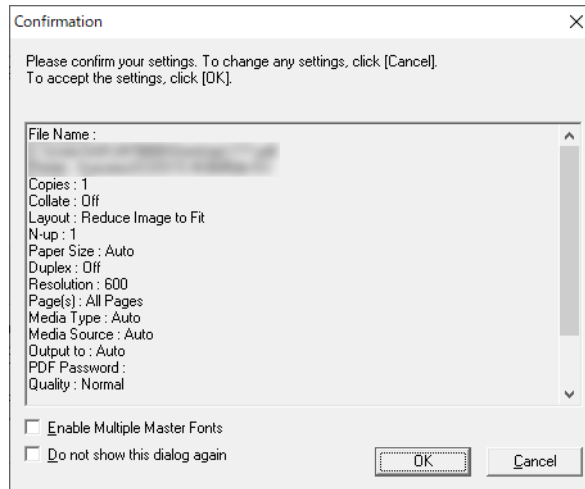

Notes





- Checking **Enable Multiple Master Font** and then clicking **OK** enable to generate a version of a character that is optically correct for the size at which it will be viewed on PDF file.
- Checking **Do not show this dialog again** and then clicking **OK** can not be displayed the **Confirmation** dialog box.

7 When you want to continue printing, click **OK**.

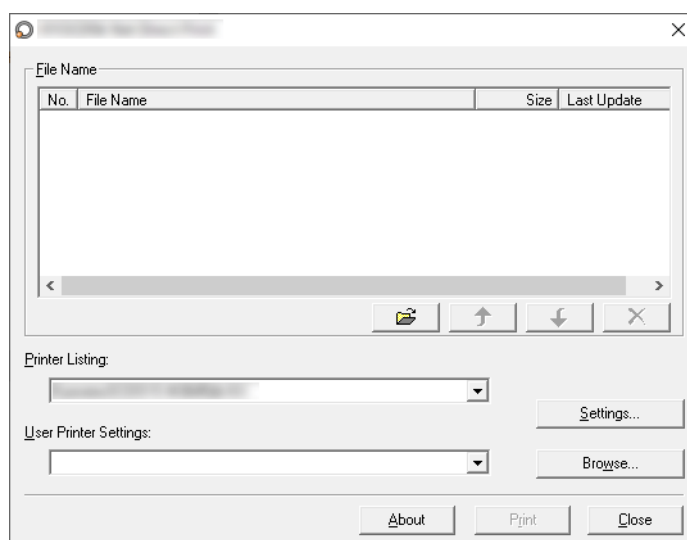
4. Names and Functions

When you start this utility, the window below appears.



Name and Icon	Description
Add button 	Displays the Open File dialog box. When you select a valid file, file name, file size and last update are displayed in the File Name list.
Up button 	Moves order of selected files up one or down one.
Down button 	Note You can also change the order by selecting a file and then dragging it to the order you want to change.
Delete button 	Deletes the selected file from the list. Note You can also delete a file by selecting a file and then pressing the Del key on the keyboard.
Printer Listing	Displays the printing systems installed in the system. Select the output target printing system here.
Settings button	Displays the printing system setting dialog box.
User Printer Settings	Displays the names of setting files saved previously.
Browse button	Displays the Open File dialog box to load previously saved setting files.
About button	Displays the version and copyright of this utility.
Print button	Starts the printing process of the file displayed in the File Name list.
Close button	Exits this utility.

5. Printing System Settings

You can make frequently used settings as default.

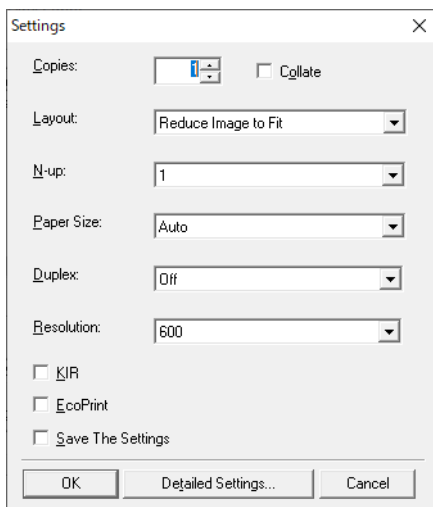

Copies

Specifies the number of copies. The default setting is 1.

Collate

Produces the specified number of copies as complete sets of documents. The default setting is disabled (not checked).

Layout

Specifies the layout of the output.

When you select **Reduce Image to Fit**, the image is enlarged or reduced to fit the printing area of the paper specified in **Paper Size**.

When you select **Through**, the image is printed in the same size as the original page regardless of paper size.

When you select **Catalog (Left to Right)**, **Catalog (Right to Left)**, **Booklet (Left Edge Binding)** or **Booklet (Right Edge Binding)**, the printing order is as follows.

• Catalog (Left to Right)

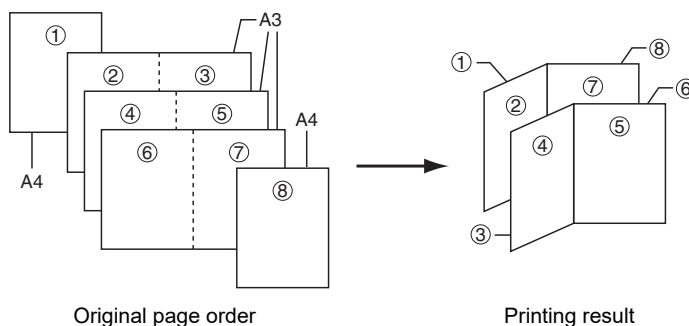

• **Catalog (Right to Left)**

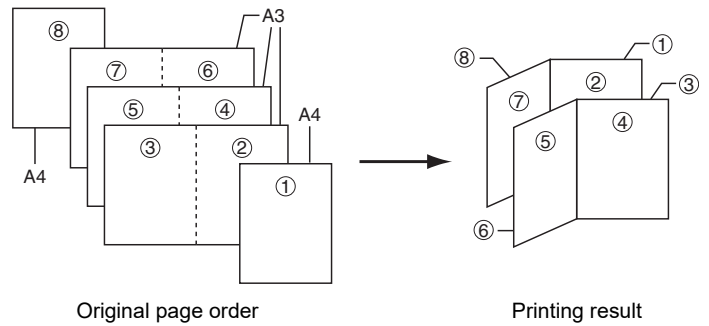

Note

If the page order is not in the same order as shown above, the printing results will vary.

• **Booklet (Left Edge Binding)**

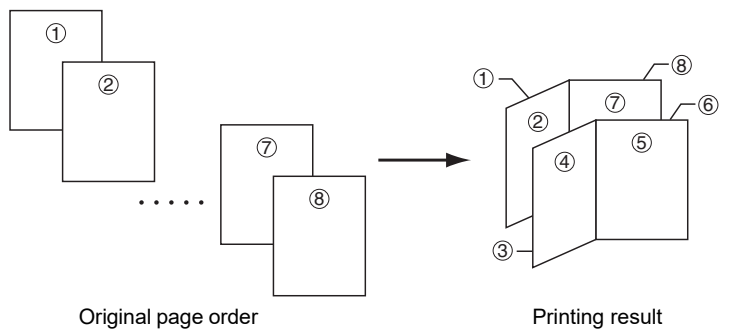

• **Booklet (Right Edge Binding)**

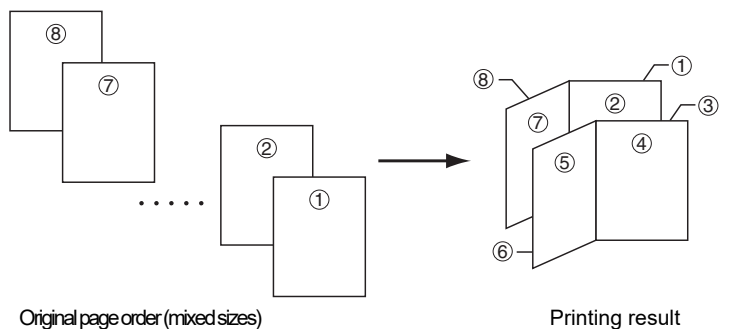

Note

Confirm the paper size and load the paper into the cassette before printing. For example, to change the booklet configured in A4 portrait into the double spread page in A3 size, load the A3 size paper. If you load the A4 paper in landscape, a single side is reduced in A5 size, and the double spread pages in A4 are printed.

N-up

Specifies the number of pages per sheet. The following value is available: **1**, **2** and **4**. The default setting is **1**.

When N-up settings 2 or 4 are used, the page layouts are as follows.

2-up

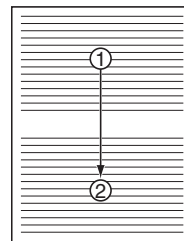
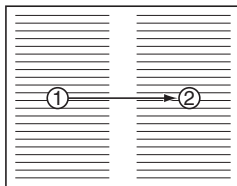

4-up

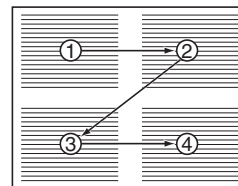
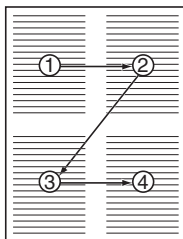

Note

If you select **Through** in Layout, the value of N-up is fixed at 1 and cannot be changed. Furthermore, if you select Catalog or Booklet, the value is fixed at 2 and cannot be changed.

Paper Size

Specifies the paper size applied to the output. The default setting is **Auto**.

Duplex

Sets 2-sided printing. The following modes are available: **Off**, **Flip on Long Edge** and **Flip on Short Edge**. The default setting is **Off**.

Notes

If you select **Catalog** or **Booklet** in **Layout**, the value of **Duplex** is fixed at the **Flip on Short Edge** and cannot be changed.

This utility does not automatically recognize whether or not a duplex printing unit is present in a printing system. Therefore, there is a possibility that the duplex printing settings set here may be invalid.

Resolution

Specifies the printing resolution. The default setting is **600**.

KIR

KIR is a smoothing function that enhances resolution, resulting in high-quality printing. The default setting is disabled (not checked).

EcoPrint

Enables the printing system to reduce the amount of toner consumption to save printing costs. The default setting is disabled (not checked).

Save The Settings

Saves settings in a file.

When checked, click **OK** to save the settings. You can select the saved file by **Load Setting File** in the main window. The default setting is disabled (not checked).

Detailed Settings

Displays another dialog box to perform more detailed settings. Information on using the **Detailed Settings** dialog box can be found on the following page.

6. Detailed Settings

You can make select media type, media source and other detailed settings in this dialog box.

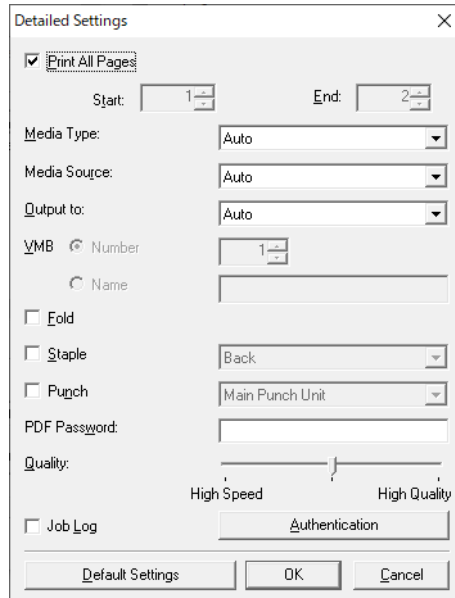

Print All Pages

Check to print all pages.

If you remove this check, the range entry boxes are active. Specify the page range for printing.

Note

If you select **Catalog** in **Layout** of the **Settings** dialog box, **Print All Pages** is automatically checked and cannot be changed.

Media Type

Selects the media type used for printing. The default setting is **Auto**.

Media Source

Specifies the paper supply cassette. The default setting is **Auto**.

Note

The setting may be ignored depending on the configuration of the printing system.

Output to

Specifies the paper output destination. The default setting is **Auto**.

Note

The setting may be ignored depending on the configuration of the printing system.

VMB (Virtual MailBox)	<p>This is active when VMB is specified as the Output to destination above. Virtual Mailbox feature, mailboxes created on the hard disk are assigned to multiple users. Jobs posted to a virtual mailbox can be printed later from the operation panel of the printing system.</p> <p>Number: specifies the mailbox by the number. the number should be 1 to 255.</p> <p>Name: specifies the mailbox by the name.</p> <p>Note The setting may be ignored depending on the configuration of the printing system.</p>
Fold	Folds copies for booklet format. The default setting is disabled (not checked).
Staple	<p>Staples each copy set. The default setting is disabled (not checked).</p> <p>When this item is enabled, the combo box is active allowing you to select that result. The following staple positions are available: Back, Booklet and Front.</p>
Punch	<p>Makes copies hole punched. The default setting is disabled (not checked).</p> <p>When this item is enabled, the combo box is active allowing you to select that result. The following value are available: Main Punch Unit and Sub Punch Unit.</p> <p>Note The setting may be ignored depending on the configuration of the printing system.</p>
PDF Password	Enter the password required to print encrypted PDF files. The password should be 32 characters maximum.
Quality	<p>You can choose the printing quality, from High Quality to High Speed. Move the slider to the left to select a High Speed or to the right to select a High Quality. The default setting is center.</p> <p>Note The setting is enabled only when the PDF file to print is PDF version 1.4 or later file and using Transparency Flattening function. Otherwise the setting is ignored.</p> <p>PDF version can be confirmed on the window displayed by which selecting from File menu > Document Properties > Summary.</p> <p>Transparency Flattening function can be confirmed on the Advanced Print Setup dialog box.</p>
Job Log	<p>Maintains a log in the system that indicates printed PDF files and the date/time of printing. Entering a check mark for this item enables the Job Log.</p> <p>For details on the Job Log, refer to the Operation Guide of the printing system.</p>

Authentication

Displays **Authentication** dialog box.

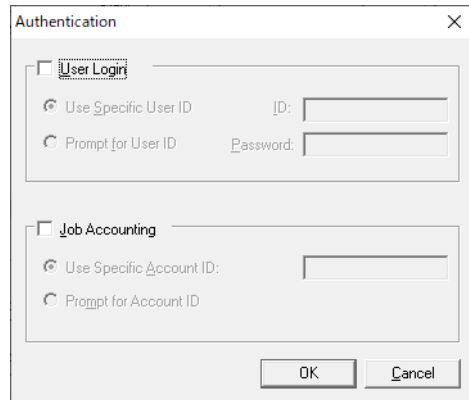

User Login

To use user login function, click **User Login** to check. For details on user login function, refer to *Operation Guide* of the printing system. Select **Use Specific User ID** when always printing with same ID. Select **Prompt for User ID** when printing with several different IDs. This prompt you to enter the **User ID** and **Password** at each time you print on the printing system.

Job Accounting

To use job accounting function, click **Job Accounting** to check. For details on job accounting, refer to *Operation Guide* of the printing system. Select **Use Specific Account ID** when always printing with same ID. Select **Prompt for Account ID** when printing with several different IDs. This prompt you to enter the **Account ID** at each time you print on the printing system.

Default Settings

Returns all settings to their initial state.

KYOCERA Document Solutions America, Inc.**Headquarters**

225 Sand Road,
Fairfield, New Jersey 07004-0008, USA
Phone: +1-973-808-8444
Fax: +1-973-882-6000

Latin America

8240 NW 52nd Terrace, Suite 301
Miami, Florida 33166, USA
Phone: +1-305-421-6640
Fax: +1-305-421-6666

KYOCERA Document Solutions Canada, Ltd.

6120 Kestrel Rd., Mississauga, ON L5T 1S8,
Canada
Phone: +1-905-670-4425
Fax: +1-905-670-8116

KYOCERA Document Solutions**Mexico, S.A. de C.V.**

Calle Arquimedes No. 130, 4 Piso, Colonia Polanco
Chapultepec, Delegacion Miguel Hidalgo,
Distrito Federal, C.P. 11560, México
Phone: +52-555-383-2741
Fax: +52-555-383-7804

KYOCERA Document Solutions Brazil, Ltda.

Alameda África, 545, Pólo Empresarial Consbrás,
Tamboré, Santana de Parnaíba, State of São Paulo, CEP
06543-306, Brazil
Phone: +55-11-2424-5353
Fax: +55-11-2424-5304

KYOCERA Document Solutions Chile SpA

Jose Ananias 505, Macul. Santiago, Chile
Phone: +56-2-2670-1900
Fax: +562-2350-7150

KYOCERA Document Solutions**Australia Pty. Ltd.**

Level 3, 6-10 Talavera Road North Ryde N.S.W, 2113,
Australia
Phone: +61-2-9888-9999
Fax: +61-2-9888-9588

KYOCERA Document Solutions**New Zealand Ltd.**

Ground Floor, 19 Byron Avenue, Takapuna, Auckland,
New Zealand
Phone: +64-9-415-4517
Fax: +64-9-415-4597

KYOCERA Document Solutions Asia Limited

13/F., Mita Centre, 552-566, Castle Peak Road Tsuen Wan,
New Territories, Hong Kong
Phone: +852-2496-5678
Fax: +852-2610-2063

KYOCERA Document Solutions**(China) Corporation**

8F, No. 288 Nanjing Road West, Huangpu District,
Shanghai, 200003, China
Phone: +86-21-5301-1777
Fax: +86-21-5302-8300

KYOCERA Document Solutions**(Thailand) Corp., Ltd.**

335 Ratchadapisek Road, Wongsawang, Bangsue,
Bangkok 10800,
Thailand
Phone: +66-2-586-0333
Fax: +66-2-586-0278

KYOCERA Document Solutions**Singapore Pte. Ltd.**

12 Tai Seng Street #04-01A,
Luxasia Building, Singapore 534118
Phone: +65-6741-8733
Fax: +65-6748-3788

KYOCERA Document Solutions**Hong Kong Limited**

16/F., Mita Centre, 552-566, Castle Peak Road Tsuen Wan,
New Territories, Hong Kong
Phone: +852-3582-4000
Fax: +852-3185-1399

KYOCERA Document Solutions**Taiwan Corporation**

6F., No.37, Sec. 3, Minquan E. Rd.,
Zhongshan Dist., Taipei 104, Taiwan R.O.C.
Phone: +886-2-2507-6709
Fax: +886-2-2507-8432

KYOCERA Document Solutions Korea Co., Ltd.

#10F Daewoo Foundation Bldg 18, Toegye-ro, Jung-gu,
Seoul, Korea
Phone: +822-6933-4050
Fax: +822-747-0084

KYOCERA Document Solutions**India Private Limited**

Second Floor, Centrum Plaza, Golf Course Road,
Sector-53, Gurgaon, Haryana 122002, India
Phone: +91-0124-4671000
Fax: +91-0124-4671001

KYOCERA Document Solutions Europe B.V.

Bloemlaan 4, 2132 NP Hoofddorp,
The Netherlands
Phone: +31-20-654-0000
Fax: +31-20-653-1256

KYOCERA Document Solutions Nederland B.V.

Beechavenue 25, 1119 RA Schiphol-Rijk,
The Netherlands
Phone: +31-20-5877200
Fax: +31-20-5877260

KYOCERA Document Solutions (U.K.) Limited

Eldon Court, 75-77 London Road,
Reading, Berkshire RG1 5BS,
United Kingdom
Phone: +44-118-931-1500
Fax: +44-118-931-1108

KYOCERA Document Solutions Italia S.p.A.

Via Monfalcone 15, 20132, Milano, Italy,
Phone: +39-02-921791
Fax: +39-02-92179-600

KYOCERA Document Solutions Belgium N.V.

Sint-Martinusweg 199-201 1930 Zaventem,
Belgium
Phone: +32-2-7209270
Fax: +32-2-7208748

KYOCERA Document Solutions France S.A.S.

Espace Technologique de St Aubin
Route de l'Orme 91195 Gif-sur-Yvette CEDEX,
France
Phone: +33-1-69852600
Fax: +33-1-69853409

KYOCERA Document Solutions Espana, S.A.

Edificio Kyocera, Avda. de Manacor No.2,
28290 Las Matas (Madrid), Spain
Phone: +34-91-6318392
Fax: +34-91-6318219

KYOCERA Document Solutions Finland Oy

Atomitie 5C, 00370 Helsinki,
Finland
Phone: +358-9-47805200
Fax: +358-9-47805212

KYOCERA Document Solutions**Europe B.V., Amsterdam (NL) Zürich Branch**

Hohlstrasse 614, 8048 Zürich,
Switzerland
Phone: +41-44-9084949
Fax: +41-44-9084950

KYOCERA Bilgitas Document Solutions**Turkey A.S.**

Altunizade Mah. Prof. Fahrettin Kerim Gökay Cad. No:45
34662 ÜSKÜDAR İSTANBUL, TURKEY
Phone: +90-216-339-0020
Fax: +90-216-339-0070

KYOCERA Document Solutions**Deutschland GmbH**

Otto-Hahn-Strasse 12, 40670 Meerbusch,
Germany
Phone: +49-2159-9180
Fax: +49-2159-918100

KYOCERA Document Solutions Austria GmbH

Wienerbergstraße 11, Turm A, 18. OG, 1100 Wien,
Austria
Phone: +43-1-863380
Fax: +43-1-86338-400

KYOCERA Document Solutions Nordic AB

Esbogatan 16B 164 75 Kista, Sweden
Phone: +46-8-546-550-00
Fax: +46-8-546-550-10

KYOCERA Document Solutions Norge Nuf

Olaf Helsetsv. 6, 0619 Oslo, Norway
Phone: +47-22-62-73-00
Fax: +47-22-62-72-00

KYOCERA Document Solutions Danmark A/S

Ejby Industrivej 60, DK-2600 Glostrup,
Denmark
Phone: +45-70223880
Fax: +45-45765850

KYOCERA Document Solutions Portugal Lda.

Rua do Centro Cultural, 41 (Alvalade) 1700-106 Lisboa,
Portugal
Phone: +351-21-843-6780
Fax: +351-21-849-3312

KYOCERA Document Solutions**South Africa (Pty) Ltd.**

KYOCERA House, Hertford Office Park,
90 Bekker Road (Cnr. Allandale), Midrand, South Africa
Phone: +27-11-540-2600
Fax: +27-11-466-3050

KYOCERA Document Solutions Russia LLC.

Building 2, 51/4, Schepkina St., 129110, Moscow,
Russia
Phone: +7(495)741-0004
Fax: +7(495)741-0018

KYOCERA Document Solutions Middle East

Dubai Internet City, Bldg. 17,
Office 157 P.O. Box 500817, Dubai,
United Arab Emirates
Phone: +971-04-433-0412

KYOCERA Document Solutions Inc.

2-28, 1-chome, Tamatsukuri, Chuo-ku
Osaka 540-8585, Japan
Phone: +81-6-6764-3555
<http://www.kyoceradocumentsolutions.com>

